

TR-UM06-IN Box Camera Mount



Specifications

Bracket	TR-UM06-IN
Application	Indoor, box camera pendant or wall installation
Dimensions	Φ80mmx155.9mm(Φ3.1" x6.1")
Weight	0.3kg(0.66lb)
Bearable Load	10kg(22lb)
Material	Aluminum alloy
Adjustable Range	Horizontal:0° ~360° ; Vertical: 0° ~90°

Dimensions

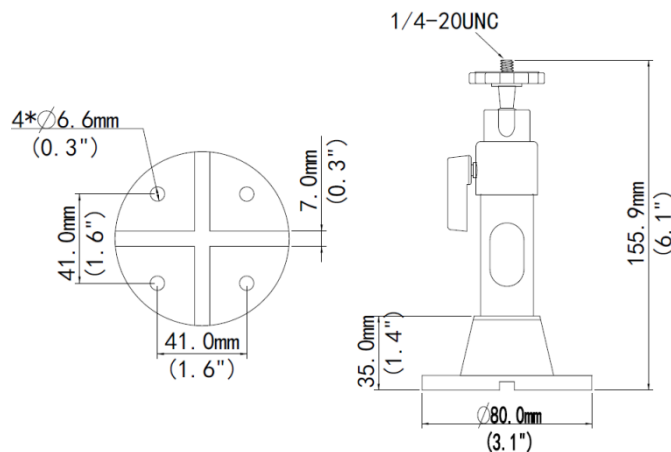

Zhejiang Uniview Technologies Co.,Ltd.

South Tower, Building 10, Wanlun Science Park, 88 Jiangling Road, Hangzhou, P.R.China 310051

Email: overseasbusiness@uniview.com; globalsupport@uniview.com

<http://www.uniview.com>

©2015 Zhejiang Uniview Technologies Co.,Ltd. All rights reserved.

*Product specifications and availability are subject to change without notice.